



ALRITE

Fireshield System

PRODUCT & INSTALLATION TECHNICAL MANUAL

Oct 2024

Index

1.Product Overview	2
2.Scope of use	2
3.NZBC Compliance.....	4
4.Technical Specification	5
5.Accessories	8
6.Design Guideline.....	12
7.Installation Guideline.....	17
8.Maintenance	25
9.Warranty	26
Alrite Fireshield	28

1. Product Overview

1.1 The Alrite Fireshield Fire Rated System is a cutting-edge fire-resistant plasterboard solution, designed to meet the demanding requirements of modern construction. This system is specifically engineered to provide robust fire protection, making it an essential component in the construction of both residential and commercial buildings. The Alrite Fireshield system incorporates advanced gypsum technology, with boards formulated to resist high temperatures and slow the spread of fire, ensuring the safety and integrity of the building structure.

The Alrite Fireshield system is suitable for a wide range of applications, from high-traffic commercial settings requiring stringent fire safety measures to residential environments where safety and compliance are paramount. The system's versatility and ease of installation make it an ideal choice for projects of all sizes.

1.2 Product Description

The Alrite Fireshield system consists of specially formulated plasterboards, which are available in 13mm thicknesses, 1200mm x 2400mm. These boards are designed to be installed as part of a fire-resistant wall or ceiling system, providing protection for up to 120 minutes in the event of a fire. The core of the Fireshield boards is made from enhanced gypsum, combined with fire-retardant additives that improve the board's ability to withstand high temperatures.

These boards are ideal for:

- **Load-bearing walls:** Ensuring the structural integrity of the building is maintained during a fire.
- **Non-load-bearing walls:** Providing essential fire compartmentation in both residential and commercial buildings.

- **Ceilings:** Protecting against fire spread through floors and ceilings.

The Fireshield boards are designed to be used in conjunction with other fire-rated components, such as fire-rated sealants and specific fixing systems, to create a comprehensive fire-resistant barrier.

1.3 Applications

The Alrite Fireshield system is versatile and can be used in a variety of construction scenarios, including:

- **Residential Buildings:** Ideal for internal walls and ceilings where fire safety is a priority. The system provides the necessary protection in living spaces, bedrooms, and communal areas.
- **Commercial and Industrial Buildings:** The system is suitable for creating fire partitions, protecting escape routes, and ensuring that critical areas are shielded from the spread of fire. It is especially useful in high-risk areas such as server rooms, storage facilities, and manufacturing plants.
- **Public Buildings:** Schools, hospitals, and government buildings can benefit from the enhanced fire protection offered by the Alrite Fireshield system, ensuring the safety of occupants and compliance with stringent fire safety regulations.

2. Scope of use

2.1 Intended Use

The Alrite Fireshield Fire Rated System is specifically designed for use in internal applications where fire resistance is required. This includes:

- **Load-bearing and non-load-bearing walls:** The system can be installed in both steel-framed constructions, providing essential fire protection for structural and non-structural elements of the building.
- **Ceilings:** The system can be used to protect against the vertical spread of fire, ensuring that

fire does not easily move between floors.

- **Fire partitions:** Ideal for creating compartments within buildings to limit the spread of fire and protect escape routes.

2.2 Limitations of Use

While the Alrite Fireshield system offers robust fire protection, it is important to recognize its limitations:

- **External Environments:** The system is not suitable for use in external environments or where it may be exposed to moisture or weather conditions.
- **Wet Areas:** The system should not be used in continuously wet areas such as showers, bathrooms, or kitchens unless adequate moisture protection is provided.
- **Direct Exposure to Heat:** The boards must not be exposed to direct heat sources or temperatures exceeding 52°C for prolonged periods, as this can compromise the integrity of the fire-resistant gypsum core.

2.3 Compliance Requirements

To achieve the intended fire resistance, the Alrite Fireshield system must be installed as part of a complete system that includes specific framing, fixing, and sealing methods. These components work together to ensure that the system meets the requirements of the New Zealand Building Code (NZBC) for fire-resistant construction. Compliance with NZBC clauses B1 (Structure), B2 (Durability), and C3 (Fire affecting areas beyond the fire source) is critical for the effective performance of the system.

3. NZBC Compliance

Alrite Fireshield, if designed, used, installed and maintained in accordance with the product technical manual and Codemark conditions, will meet or contribute to meeting the following provisions of NZ Building Code:

3.1 Clause B1: Structure

Performance B1.3.1, B1.3.2, and B1.3.4 (a), (b), (d)

The Alrite Fireshield system is engineered to maintain structural integrity when exposed to fire. It meets the requirements for loads arising from self-weight, wind, earthquake, and impact, as specified in Clause B1 of the NZBC. The system ensures that the building remains stable and secure during a fire, minimizing the risk of structural collapse and providing critical time for evacuation and firefighting efforts.

B1.3.1: General structural performance – The system contributes to maintaining the overall stability of the structure.

B1.3.2: Resistance to wind and earthquake – The system is tested to withstand lateral forces without compromising its fire-resistant properties.

B1.3.4 (a), (b), (d): Structural sufficiency – The system supports the building's capacity to bear loads even under the stress of high temperatures during a fire.

3.2 Clause B2: Durability

Performance B2.3.1 (a), (b), (c)

The Alrite Fireshield system is designed to provide a long service life, meeting the durability requirements of the NZBC:

- B2.3.1 (a): Not less than 50 years – The fire-resistant properties of the system are engineered to last for the life of the building, provided that the system is kept dry and maintained as per the installation guidelines.
- B2.3.1 (b): 15 years – The system's components, such as the fire-resistant linings and fixings, are expected to maintain their integrity and effectiveness for at least 15 years.
- B2.3.1 (c): 5 years – Short-term durability of components, particularly those exposed to environmental conditions, is assured for up to five years.

Regular inspections and maintenance are recommended to ensure the system continues to meet these durability requirements.

3.3 Clause C3: Fire Affecting Areas Beyond the Fire Source

Performance C3.4(a) and C3.7

The Alrite Fireshield system provides passive fire protection by limiting the spread of fire and smoke. It helps contain the fire to its source, protecting other areas of the building and allowing occupants more time to evacuate safely. This is particularly critical in multi-story buildings where vertical fire spread through floors and ceilings can be catastrophic.

- C3.4(a): Passive fire protection – The system effectively prevents the spread of fire and smoke, reducing the risk of fire affecting areas beyond the fire source.
- C3.7: Protection against fire spread – The system contributes to the overall fire safety strategy of the building by creating effective fire compartments and barriers.

3.4 Clause F2: Hazardous Building Materials Performance F2.3.1

The materials used in the Alrite Fireshield system are non-toxic and do not present a health hazard to building occupants. The plasterboards are free from hazardous substances, making them safe for use in all types of buildings, including residential, commercial, and public buildings.

F2.3.1: Safe for indoor use – The system ensures that no harmful materials are released into the building environment, contributing to a safe and healthy indoor air quality.

4. Technical Specification

The technical specifications of the Alrite Fireshield system are crucial for ensuring that the system performs as intended under fire conditions. This section provides detailed information on the composition, dimensions, and performance characteristics of the Fireshield boards.

4.1 Fireshield Plasterboard Composition

The Alrite Fireshield plasterboards are composed of a gypsum core that has been enhanced with fire-retardant additives. These additives improve the board's ability to resist high temperatures and slow the progression of fire, providing essential protection for the building's occupants and structural components.

- Core Composition: Gypsum with fire-resistant additives.
- Paper Liner: The boards are encased in a high-quality paper liner that adds to their strength and durability while also serving as a barrier against moisture penetration.

4.2 Physical Properties

- Thickness: Available in 13mm. The density of the boards contributes to their ability to resist fire and heat, with thicker boards offering higher fire resistance ratings.
- Width: Standard width of 1200mm.
- Length: Available in lengths is 2400mm.
- Weight: the 13mm board weighs approximately 12kg/m².
- Thermal Resistance: The thermal resistance (R-value) is 0.08m² K/W for 13mm boards, contributing to the overall insulation of the building. Alrite Fireshield is light red face paper, with two edge profile options.
- The system also contributes to sound insulation, helping to reduce noise transmission between rooms and floors, which is particularly beneficial in multi-occupancy buildings such as

apartments, hotels, and office buildings.

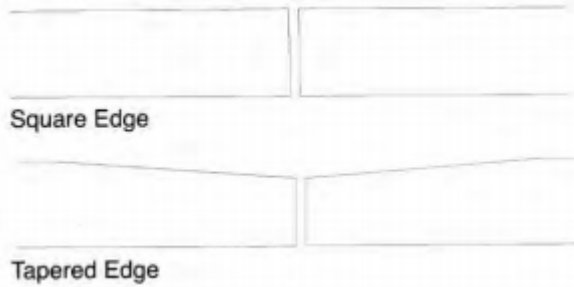

4.3 Standards Compliance

Alrite Fireshield complies with the following standards:

- AS/NZS 2588: 2018 Gypsum Plasterboard: Ensures the board meets industry standards for gypsum products.
- AS/NZS 2589: 2017 Gypsum Lining: Specifies the requirements for the application and finishing of gypsum linings in buildings.
- EN 520: 2004 Gypsum Plasterboard: Establishes the criteria for gypsum plasterboard in construction, ensuring it meets European standards for quality and performance.

4.4 Fire Resistance Ratings (FRR)

The fire resistance ratings (FRR) for the Alrite Fireshield system have been rigorously tested to ensure compliance with fire safety standards:

- Two layers of Fireshield on each side: Provides up to 120 minutes of fire resistance. (120/120/120)
- One layer of Fireshield on each side: Provides up to 60 minutes of fire resistance. (60/60/60)

These ratings are based on the system's ability to maintain structural integrity, insulation, and integrity during a fire, preventing the spread of fire and protecting the structural components of the building. Refer to technical drawings in clause 6.

4.5 Ceiling Battens

Knauf MF ceiling channel or similar

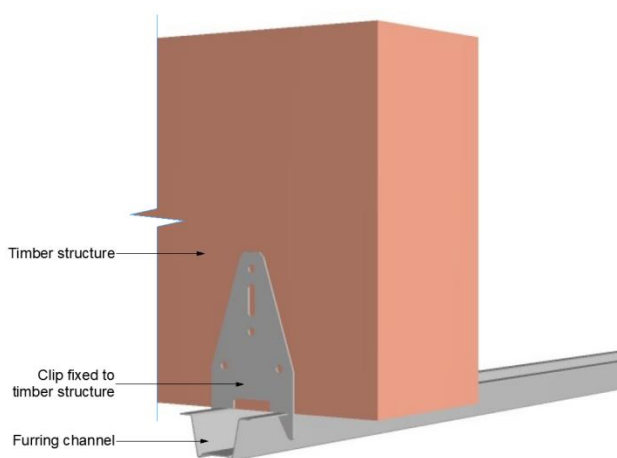
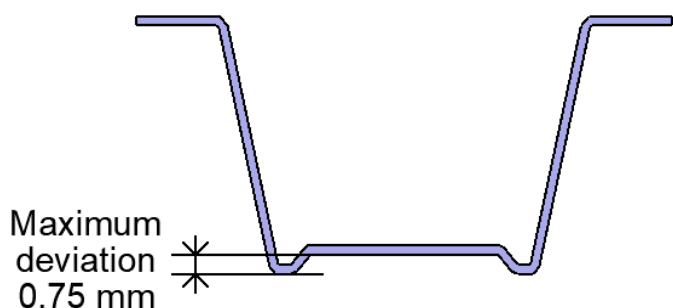

Timbers ceiling battens as specified in NZS 3604:2011

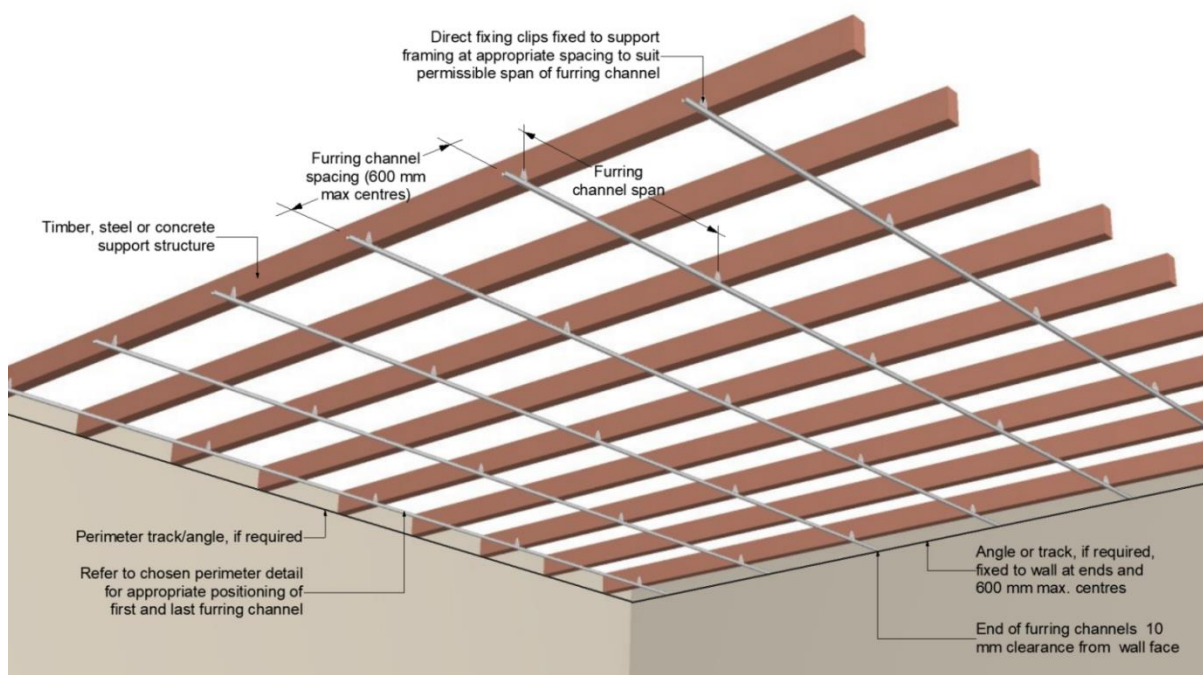

4.6 Handling and Storage

Proper handling and storage are crucial to maintaining the quality of Alrite Fireshield before installation:

- Plasterboards are supplied on timber bearers.
- Packs should be lifted with a fork-lift truck and stacked not more than one-high on a flat surface to preserve stability.
- The best results are achieved when Alrite Fireshield is treated as a finishing material and protected from damage.
- Sheets must be stacked flat and kept dry at all times.
- Sheets must be carried on edge and not dragged.
- All accessories must be kept dry.
- They should be stored in a clean dry environment.

5. Accessories

The performance of the Alrite Fireshield Fire Rated System is greatly influenced by the quality and correct usage of its accessories. This section details the recommended accessories, including fasteners, sealants, and other components necessary for ensuring the system meets its fire resistance ratings and overall performance requirements.

5.1 Fasteners

Note: For two layer fixing require not less than 40mm long. Refer clause 6.

5.1.1 Screws for Timber Framing: Use 35mm and 25mm x 6g bugle head screws with coarse threads. These screws provide a secure hold in timber framing, ensuring the board remains stable and secure.



KNAUF DRYWALL SCREWS - SELF DRILLING

Black phosphated self drilling and self tapping screws with countersunk Phillips heads for fixing plasterboard to metal and timber framing. For use with light gauge metal up to 0–6mm thick. Tested to DIN 18182, 50021 and 50942. Each box includes one drill bit tip.

Dimensions (mm)		Pack Details	
Size	Diameter	Items per Pack	kg (Approx)
25	3.5	1000	1.8
35	3.5	1000	2.5

5.1.2 Screws for Steel Framing: Use 35mm x 6g screws with drill bit tips for fixing to steel frames with a thickness of 0.7mm to 1.2mm BMT (base metal thickness). These screws ensure proper

penetration and a strong bond with the steel framing.



5.1.3 Nails: Use 40 x 2.8mm galvanized flat head nails or 30mm, 40mm, or 50mm ring shank galvanized flat head nails for timber framing. These nails provide an alternative fastening option where screws may not be suitable.



5.2 Adhesive and Sealants

5.2.1 Adhesives: Use Alrite or Knauf bonding compounds, which are compatible with moisture-resistant boards. These adhesives should be BRANZ appraised and meet the requirements of AS 2753 for bonding gypsum plaster linings to wood and metal framing. Ensure the adhesive is applied correctly to avoid voids or gaps that could compromise the moisture resistance.



Setting time 2-3 hours.
Non-combustible to BS476: Part 4: 1970. Use within 4 months.
Estimating Guide: 5m² per bag

5.2.2 Sealants

Sealants are critical for maintaining the fire resistance of joints and penetrations in the Fireshield system. The following sealants are recommended:

Fire-Rated Acrylic Sealant: A water-based, gun-applied sealant that dries to a flexible finish. This sealant is used to seal joints, gaps, and penetrations to prevent the passage of fire and smoke. It must be applied around all penetrations, including electrical outlets, plumbing pipes, and ductwork, to maintain the integrity of the fire-rated system.

Application: Should be applied in a continuous bead, ensuring full coverage. The sealant should adhere well to both the Fireshield board and the surrounding substrates.

Intumescent Sealant: For applications where higher temperatures are expected, an intumescent sealant that expands when exposed to heat is recommended. This type of sealant provides additional protection by closing off gaps and holes during a fire.

Application: Used around larger penetrations and in areas where movement is expected. The intumescent sealant ensures that any expansion or

contraction of the building components does not compromise the fire integrity.



Use within 12 months.
Estimating Guide: For a 10mm bead, 30-40 linear metres per cartridge.

5.3 Tape products

5.3. Jointing Tape: 50mm wide perforated fire-rated tape is used to reinforce the joints between Fireshield boards. The tape should be applied over all joints after the first coat of joint compound has been applied.

Application: The tape must be fully embedded in the joint compound to prevent air pockets, which could compromise the fire resistance.



5.4 Jointing and Ancillaries

Fire-Rated Joint Compound: A specially formulated compound used for filling joints and covering fasteners. This compound is applied in multiple layers, with each layer being allowed to dry before the next is applied.

Application: Typically, three coats of compound are applied, with sanding between each coat to achieve a smooth finish. The final coat should be sanded lightly to prepare for painting or other finishes.

5.4.1 Corner Beads: Use galvanized steel corner beads to protect external corners from damage and ensure a clean, sharp finish. These beads should be embedded in the jointing compound for a seamless finish.



31x31x0.4 in 3,000mm or 4,000mm length

5.4.2 Expansion Trims: Use galvanized steel movement control joints in large wall or ceiling areas to accommodate structural movement and prevent cracking. These joints should be installed according to the technical literature, ensuring they align with the board joints.

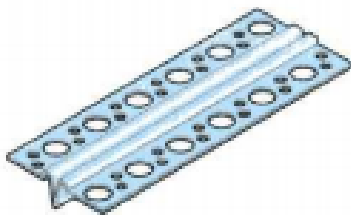

60mm x 3,000mm

5.5 Joint filler

Fast setting gypsum based compound for bedding joints by hand application.

5.4.3 Ceiling channel or similar, galvanized steel section for ceiling.

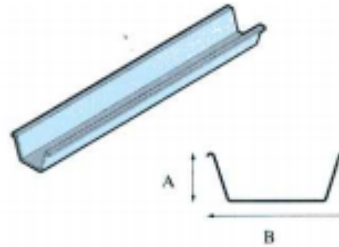

Gauge	Size/Webb (B)	Length	Flange (A)
0.55	80	3600	26

5.4.4 Angle Sections: Use galvanized mild steel angles for use with partitions, column encasements, and suspended ceilings. These sections provide additional structural support and help maintain the integrity.

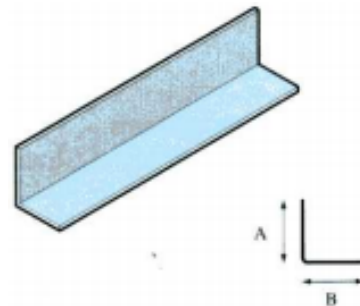

Gauge	Width (A)	Length	Leg ~ (B)	Angle
0.7	25	3000	25	90
			50	90



5.6 Insulation and Soundproofing Materials

While the primary function of the Alrite Fireshield system is fire protection, the inclusion of insulation and soundproofing materials can enhance the overall performance of the system:

Thermal Insulation: Fire-resistant insulation materials, such as mineral wool (Rock wool applied during the fire test), can be installed within the wall or ceiling cavity to improve thermal performance while maintaining fire resistance.

Application: Insulation should be cut to fit snugly within the framing, ensuring no gaps are left that could compromise the fire rating.

Acoustic Insulation: In environments where sound reduction is important, acoustic insulation materials can be used alongside the Fireshield system. These materials should be non-combustible and compatible with fire-rated systems.

Application: Acoustic insulation is typically installed in a similar manner to thermal insulation, with attention to ensuring complete coverage of the cavity.

6. Design Guideline

Designing with the Alrite Fireshield Fire Rated System requires careful consideration of building codes, structural requirements, and the specific needs of the project. This section provides guidelines to help ensure that the system is designed and implemented to achieve its full fire-resistant potential.

6.1 Framing Requirements

The framing system used in conjunction with the Alrite Fireshield system must meet the following criteria:

- **Steel Framing:** For steel-framed constructions, the framing must comply with AS/NZS 4600, ensuring that it is capable of supporting the Fireshield system under both normal conditions and during a fire. Steel framing must be protected from corrosion, particularly in areas exposed to moisture.
- **Framing Spacing:** The spacing of the framing members should not exceed 600mm centers. This ensures adequate support for the boards and helps maintain the integrity of the fire-rated system.

6.2 Control Joints

Control joints are essential in large walls or ceilings to accommodate movement and prevent cracking, which could compromise the fire resistance:

- **Placement of Control Joints:** Control joints should be placed at intervals not exceeding 12 meters in walls and 15 meters in ceilings. In areas subject to significant movement, such as long corridors or expansive ceilings, more frequent placement may be necessary.
- **Construction of Control Joints:** Control joints

should be constructed using appropriate materials, such as flexible fire-rated sealants or pre-formed joint profiles. These joints must be designed to maintain the fire integrity of the system.

6.3 Penetrations and Openings

Penetrations and openings in the Fireshield system, such as those for plumbing, electrical outlets, and HVAC systems, must be carefully managed to maintain fire resistance:

Sealing Penetrations: All penetrations should be sealed using fire-rated sealants or intumescent materials that expand during a fire to close off the penetration. This prevents fire and smoke from passing through the openings.

Fire Stopping: Where larger openings are necessary, such as for ductwork or large conduit runs, fire-stopping systems should be employed. These systems may include fire collars, wraps, or other products designed to expand and seal the opening in the event of a fire.

6.4 Ceiling Design

The design of ceilings incorporating the Alrite Fireshield system must ensure that the fire-resistant properties are maintained across the entire surface:

- **Suspended Ceilings:** In suspended ceiling systems, the Fireshield boards must be installed with appropriate hangers and supports to ensure they remain in place during a fire. The suspension system itself must be fire-rated to the same level as the Fireshield boards.
- **Direct Fix Ceilings:** For ceilings where the Fireshield boards are directly fixed to the framing, it is important to ensure that the framing is adequately supported and that the fixing patterns specified in the installation guidelines are strictly followed.
- **Insulation in Ceilings:** Where insulation is

installed above or within the ceiling, it must be non-combustible and compatible with the fire rating of the ceiling system. Insulation should be installed without gaps and should not compress the Fireshield boards, as this could reduce their effectiveness.

6.5 Impact Resistance

Alrite Fireshield offers good resistance to soft body impacts, making it suitable for use in residential and light commercial applications. However, if the board is damaged, it can be repaired using standard plasterboard patching techniques. For more severe damage, consult a professional to ensure the repair maintains the board's moisture resistance and structural integrity.

6.6 Fire Prevention Measures

The Alrite Fireshield system must be designed with fire prevention in mind, ensuring that all aspects of the installation contribute to the overall fire safety of the building:

- **Clearance from Heat Sources:** The Fireshield boards must be installed with sufficient clearance from heat sources such as fireplaces, heaters, flues, and chimneys. The NZBC Acceptable Solutions C/AS1-C/AS6 and Verification Method C/VM1 provide detailed guidance on the required clearances and protective measures.
- **Fire Compartmentation:** The system should be used to create effective fire compartments

within the building, limiting the spread of fire and smoke. This is particularly important in multi-occupancy buildings where fire spread can pose a significant risk to occupants.

6.7 Internal Surface Finishes and Fire Propagation

Without any applied finish, Alrite Fireshield is classified under material Group Number 1-S. This classification allows the board to be used in most building types, including those with sleeping (residential) risk group classifications. When an additional finish, such as paint or tiles, is applied, ensure that the Group Number for the complete lining system is obtained from the finish manufacturer or supplier.

6.8 Water-Splash Areas

The Alrite Plasterboard Fireshield Systems are not suitable for installation in areas where they will be exposed to direct, constant moisture, such as shower cubicles or behind baths. These areas typically experience prolonged exposure to water, which can compromise the performance of the plasterboard. However, the Alrite Fireshield System may be used in water-splash areas, such as near sinks or in kitchens, provided that adequate protection is in place as required by NZBC Clause E3 (Internal Moisture). This protection might include waterproofing membranes or other moisture-resistant treatments to ensure that the Fireshield System remains effective and durable over time.

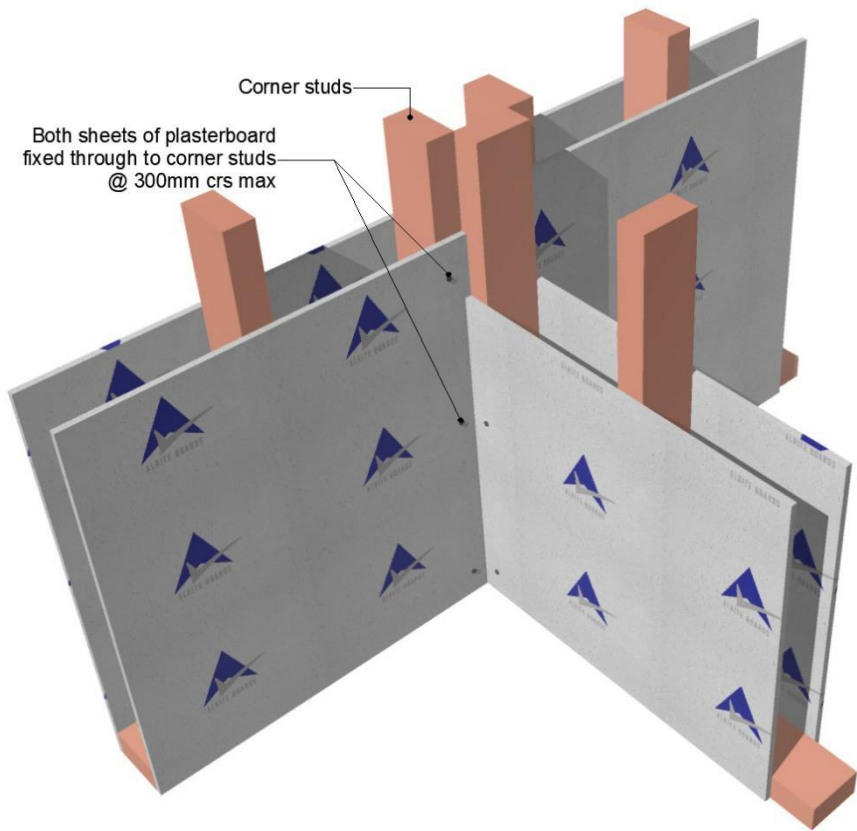
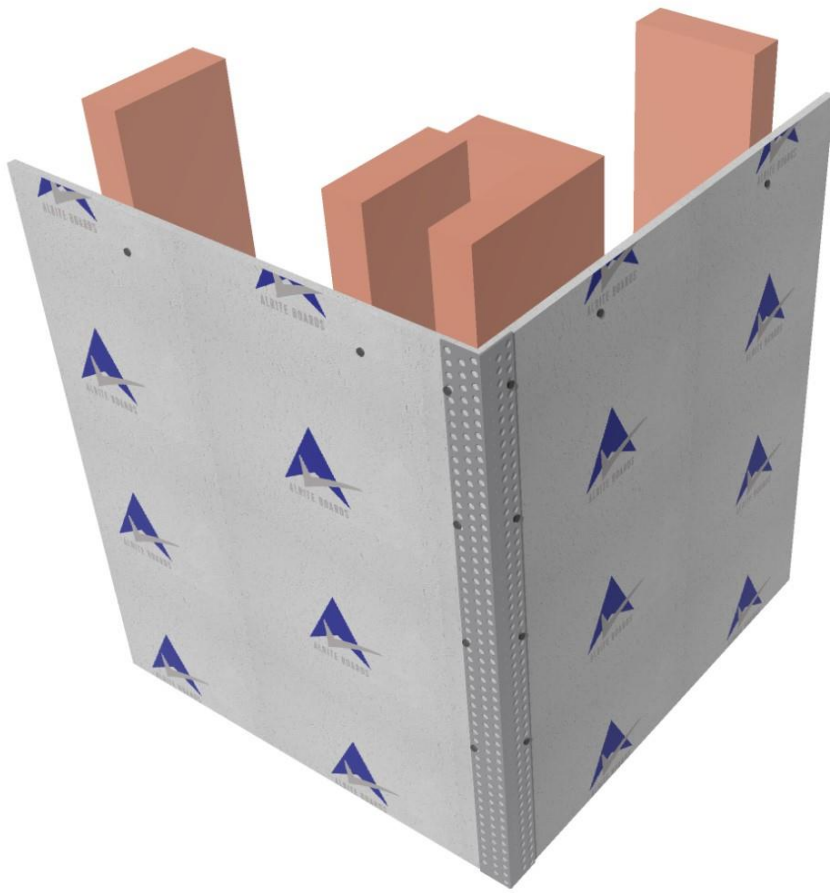

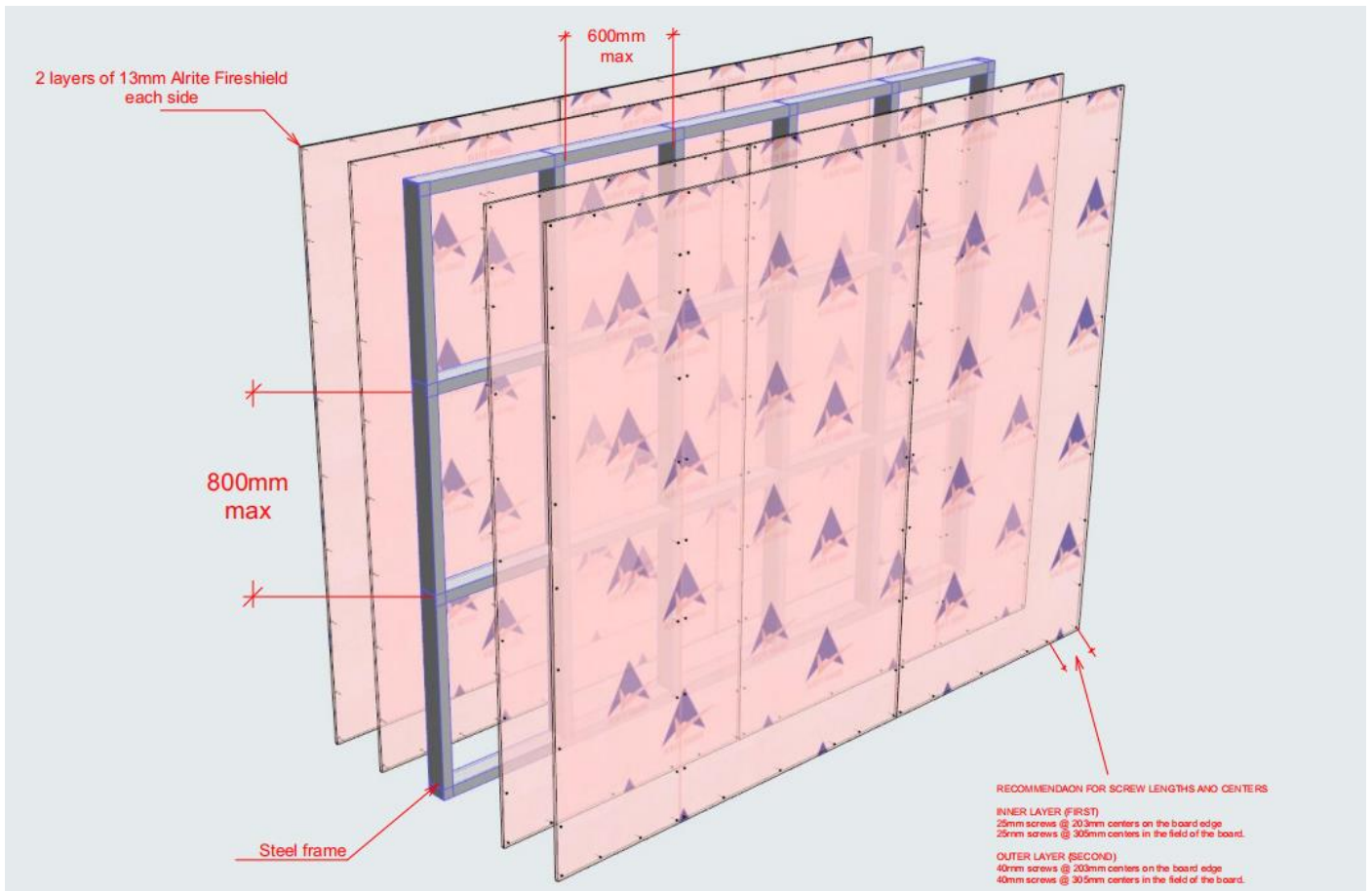

Two layers on each side of steel frame - 120/120/120

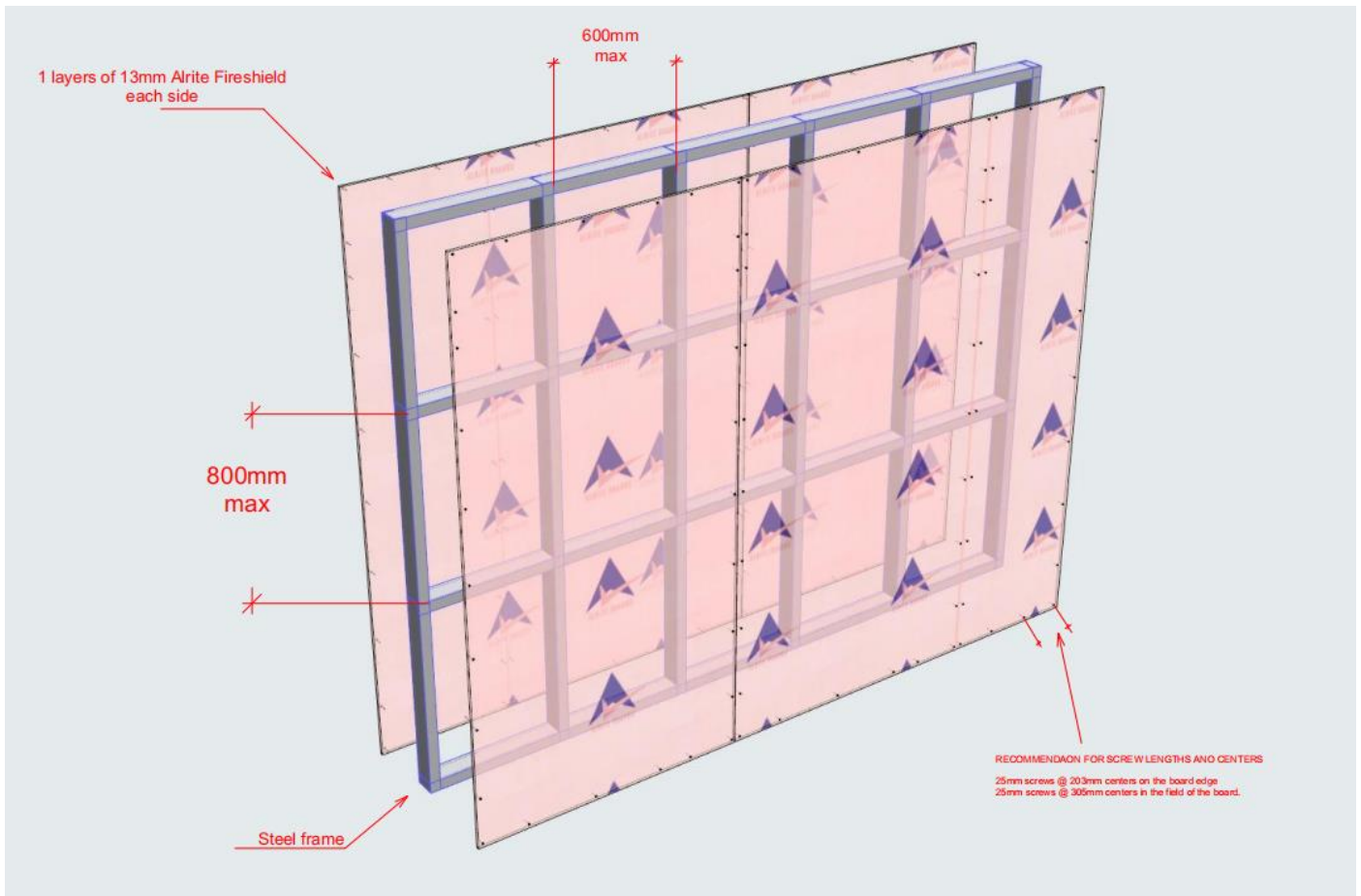

One layer on each side of steel frame - 60/60/60

7. Installation Guideline

Proper installation of the Alrite Fireshield Fire Rated System is critical to achieving the intended fire resistance and overall performance. This section provides step-by-step guidance on the installation process, ensuring that the system is installed correctly and complies with relevant building codes.

7.1 Installation Skill Level Requirement

The installation of the Alrite Fireshield system requires a high level of skill and experience in fire-rated construction techniques. It is recommended that installation be carried out by licensed building contractors who are familiar with the New Zealand Building Code (NZBC) requirements and have experience with fire-resistant systems. Installers should also be trained in the specific installation procedures for Alrite Fireshield products.

7.2 Cutting and Preparation

- **Cutting:** Alrite Fireshield can be cut using standard plasterboard techniques. Score the face paper with a sharp knife and snap the board along the scored line. Cut through the back paper to complete the cut. For more precise cuts, use a saw or a metal straightedge as a guide.
- **Edge Preparation:** After cutting, smooth the edges with a knife to remove any loose paper or gypsum dust. This ensures a clean, tight joint when the boards are installed.

7.3 Health and Safety

- **Dust Control:** Cutting and sanding Alrite Fireshield generates gypsum dust, which can irritate the respiratory system. Always work in a well-ventilated area and wear a suitable dust mask to protect against inhalation.
- **Personal Protective Equipment (PPE):** Wear gloves to protect your hands from sharp edges

and eye protection to prevent dust from getting into your eyes. Ensure all PPE is worn correctly and maintained in good condition.

7.3.1 The dust generated from sanding joint compounds can irritate the respiratory system. It is advisable to wear an appropriate face mask during these activities to mitigate inhalation risks.

7.3.2 Hazards Identification

Cutting and sanding of plasterboard or cove may generate excessive dust.

Gypsum dust may irritate eyes or sensitive skin; it may irritate the respiratory system.

It is better for the operator to wear non-restrictive clothing, especially avoiding constrictions at neck and wrist etc. It is recommended that work clothing should be washed separately from other family clothing.

7.3.3. Composition/Information on ingredients

Plasterboard comprises in general of a core of calcium sulphate dihydrate encased in paper liners. Minor additives include starch, foaming agents and dispersants.

7.3.4. First Aid Measures

Inhalation: Remove the person to fresh air.

Skin contact: Rinse skin with running water and then wash with water and soap.

Eye contact: Irrigate with plenty of water and obtain medical advice.

Ingestion: Wash mouth out and drink plenty of water.

Please note: Should any symptoms persist obtain medical assistance.

7.3.5. Fire-fighting measures

Plasterboard and cove have limited combustibility.

7.3.6. Accidental release measures

The formation of dust should be controlled and suppressed, collect released dust and put into bags. Prevent these products from contaminating drains and watercourses.

7.3.7 Handling and Storage

Plasterboards are supplied shrink wrapped on timber bearers. Packs should be lifted with a fork lift truck, the forks being set so there is an even weight distribution and no deformation of the pack. Ensure handling equipment is of adequate capacity and that the personnel are advised of handling procedures and safety clothing. Care should be taken at all times to avoid strain to the handlers. Boards should not be lifted at the short edges or carried horizontally. Carry the boards on the edge, two persons per board by supporting one long edge and gripping upper edge to avoid breaking due to flexing.

If timber bearers are used to store boards on site, they should be a minimum 40mm wide and placed at a maximum 450mm centres.

Plasterboard is not designed to support body weight; fixers must work from an independent support system.

Personal protection

Occupational exposure limits

Substance	Total inhalable	Total respirable
Gypsum	10mg/m ³	4mg/m ³
Limestone	10mg/m ³	4mg/m ³
Quartz	0.3 mg/m ³ (MEL)	
MMMF	5 mg/m ³ (MEL)	

Note: 8 hour TWA reference period

Respiratory: The area of work requires appropriate ventilation and dust formation should be minimised and controlled. If dust formation can not be controlled wear a half face mask.

Hand: Protective gloves can be worn; a barrier of cream can be applied to the hands to reduce the effect of hand contact.

Eye: If the formation of dust is likely to occur, safety goggles are recommended.

Skin: To avoid skin contact wear overalls and footwear.

7.3.9. Physical and chemical properties

Appearance: Plasterboard is a sold flat sheet in a paper envelope.

pH: 7 (Neutral)

7.3.10. Stability and Reactivity

Stable and unreactive.

7.3.11. Toxicological Information

Inhalation: Dust can cause short term irritation to the respiratory system, no known long term effects.

Skin contact: Prolonged or repeated contact may cause dry skin leading to irritation.

Eye contact: Short term irritation can be experienced due to dust formation.

Ingestion: Wash mouth out and drink plenty of water.

7.3.12. Disposal Considerations

Can be disposed of at an authorised landfill site in accordance with local or national regulations.

7.3.13. Other Information

This product should be used as directed by Alrite Boards. For further information consult the technical department.

An on-site risk assessment should be carried out before use. This safety data sheet:

- Supersedes all previous issues, and users are cautioned to ensure it is current. Destroy all previous data sheets, and if in any doubt, contact Alrite Boards.
- Does not replace the users own workplace risk assessment.
- Was compiled using the current safety information supplied by the distributors of the component materials.

7.4 Framing Requirements

Before installation, ensure that the moisture content of timber framing is less than 18%. For buildings that will be air-conditioned or centrally heated, maintain a moisture content range of 8-18% to prevent movement or warping of the framing after the board is installed. Ensure all framing is plumb, square, and free from defects to provide a solid, stable surface for the plasterboard.

7.5 Fixing Patterns and Fastening

Correct fixing patterns are crucial for achieving the desired fire resistance rating. The following guidelines should be followed:

7.5.1 Wall Installation:

- **Board Orientation:** Fireshield boards can be installed either vertically or horizontally on walls. When installing horizontally, stagger the vertical joints between adjacent rows to avoid continuous joints.
- **Fastening:** Use the specified fasteners (screws or nails) at the recommended spacing to secure the boards to the framing. Fasteners should be placed at 300mm centers along the perimeter and 300mm centers in the field of the board. For thinner boards, adjust spacing as specified

in the technical literature.

- **Edge Clearance:** Ensure that fasteners are placed at least 12mm from the edge of the board and 50mm from the corners to prevent splitting.

7.5.2 Ceiling Installation:

- **Suspended Ceilings:** When installing in a suspended ceiling system, ensure that the hangers and suspension grid are fire-rated and installed according to the manufacturer's specifications.
- **Direct Fix Ceilings:** For direct fix applications, follow the same fastening patterns as for walls. Ensure that the ceiling framing is adequately supported to prevent sagging.

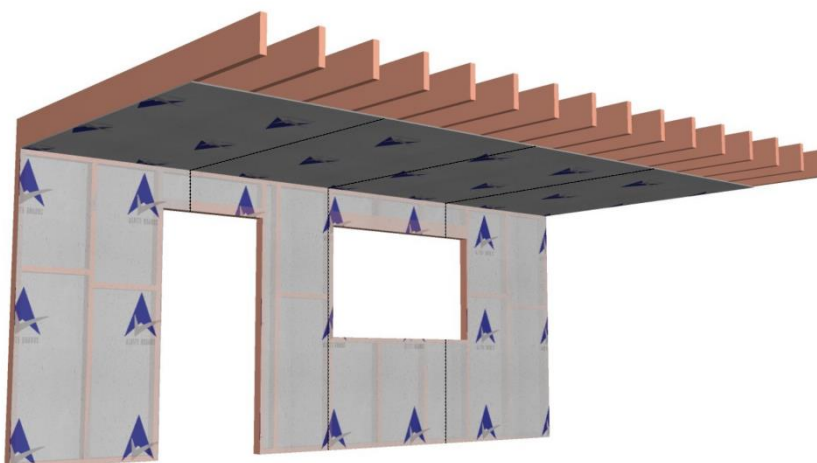
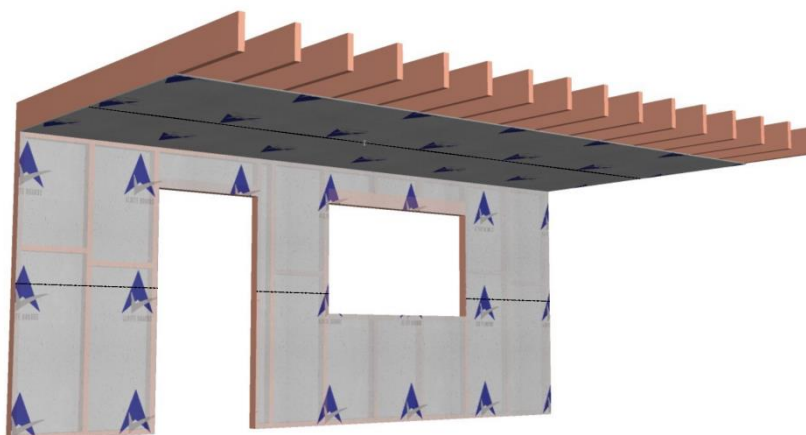

7.5.3 Edge openings

To avoid cracking of vertical joints at openings such as windows and doorways, vertical joints shall not

coincide with the edge of openings and the sheets shall be laid so that the vertical joint falls a minimum of 200 mm from the edge of the opening

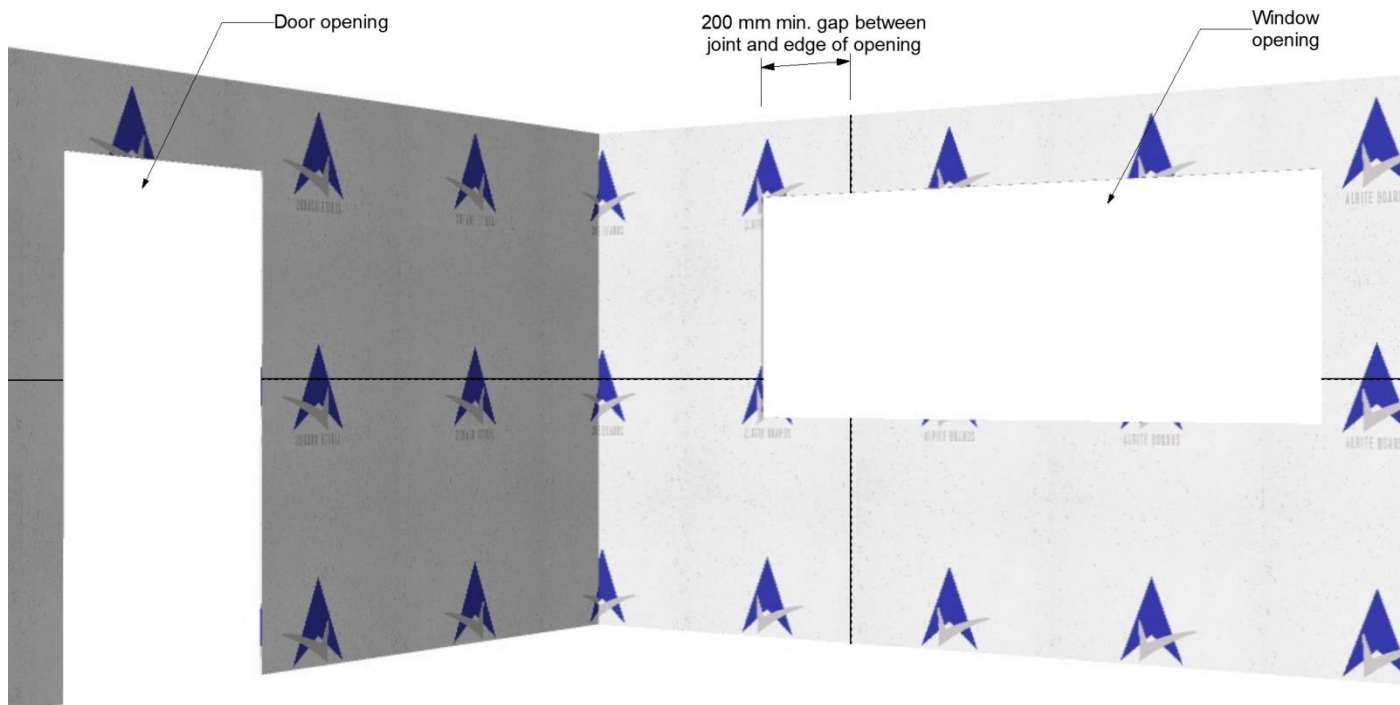

7.5.4 Jointing and Finishing

Proper jointing and finishing are essential to maintaining the fire resistance of the system. The following steps should be taken:

Joint Tape Application:

Apply a fire-rated joint compound over all joints before embedding the joint tape. Use a wide trowel to spread the compound evenly.

Embed 50mm wide perforated fire-rated joint tape into the compound, ensuring it is fully embedded without air pockets. Apply a second coat of joint compound over the tape, feathering the edges for a smooth finish.

Screw and Nail Spotting:

Cover all fastener heads with joint compound, applying at least two coats. Sand between coats to achieve a smooth surface, ensuring that the fastener heads are fully concealed.

Corner Beads and Edge Protection:

Install metal corner beads on all external corners before applying joint compound. Secure the beads with fasteners, then cover with joint compound, feathering the edges for a clean finish.

Final Finishing:

After all joints, corners, and fasteners are covered and sanded, apply a final skim coat of joint compound over the entire surface if a smooth finish is required. Sand lightly to prepare the surface for painting or other finishes.

7.5.5 Penetrations and Openings

All penetrations and openings in the Fireshield system must be properly sealed to maintain the fire resistance rating:

Small Penetrations:

For small penetrations such as electrical outlets

and plumbing pipes, use a fire-rated sealant to fill the gaps around the penetration. Ensure that the sealant is applied in a continuous bead, with no gaps.

Larger Penetrations:

For larger penetrations, such as ductwork or large conduit runs, use intumescent materials or fire collars to seal the openings. These materials expand when exposed to heat, closing off the penetration and preventing the passage of fire and smoke.

Openings for Doors and Windows:

Fire-rated doors and windows should be installed according to the manufacturer's instructions. The framing around these openings should be reinforced as needed, and all gaps should be sealed with fire-rated materials to maintain the integrity of the fire barrier.

7.5.6 Ceiling Installation

Special considerations must be taken when installing Fireshield boards on ceilings:

Ceiling Batten Spacing:

For 16mm Fireshield boards, ceiling battens should be spaced no more than 600mm apart. For 13mm boards, battens should be spaced no more than 450mm apart, and for 10mm boards, no more than 400mm apart. This spacing ensures that the boards are adequately supported and prevents sagging over time.

Insulation in Ceilings:

If installing insulation above or within the ceiling cavity, ensure it is non-combustible and compatible with the fire rating of the Fireshield system. Insulation should be installed without compressing the boards, and there should be no gaps or voids.

Control Joints:

Install control joints in ceilings where necessary to accommodate movement and prevent cracking. Control joints should be spaced according to the recommendations provided in the design guidelines.

7.5.7 Tiled Areas

In areas where the Fireshield boards will be tiled, additional considerations are required:

Board Preparation:

Ensure that the surface of the Fireshield boards is clean, dry, and free from dust before tiling. Use a suitable primer if recommended by the tile adhesive manufacturer.

Tiling Adhesive:

Use a tile adhesive that is compatible with Fireshield boards and provides sufficient bond strength. The adhesive should be applied in a continuous layer, with no voids behind the tiles that could compromise the fire resistance.

Grouting:

Use a fire-rated grout between tiles, ensuring that all joints are fully filled. The grout should be allowed to cure completely before the area is subjected to any load.

7.5.7 Final Inspection

Once installation is complete, a thorough inspection should be carried out to ensure that all aspects of the installation meet the required standards:

Check for Proper Fastening:

Verify that all fasteners are correctly spaced and properly installed. Ensure that no fasteners are over-driven, as this can weaken the hold and reduce fire resistance.

Inspect Jointing and Finishing:

Ensure that all joints, corners, and penetrations are properly sealed and finished. Look for any gaps or imperfections that could compromise the fire rating.

7.6 Plaster

7.6.1 Preparation

Undercoat and one-coat plasters

The background must be sound and free from dust and surface contamination such as releasing agents.

The background must be checked to ascertain the degree of suction and key.

In some situations, difficult backgrounds may need a preparatory treatment to ensure optimum results. Knauf Primer are specially formulated for this purpose.

7.6.2 Finishing Plasters

The background should be firm and ready to receive a finishing coat. If the undercoat is very dry, pre-wet to reduce suction. If applying a finish to a sand & cement backing, ensure that the correct ratio of sand to cement has been used, that the background has had sufficient time to cure and is free from cracking and crazing. Excessive lime content in sand & cement can lead to efflorescence.

If finishing on plasterboard, ensure its free from dust and surface contamination.

Plasterboards with moisture resistant qualities require a pretreatment with Knauf Betokontakt.

Mixing Knauf plasters must be mixed in a clean bucket. The use of dirty water or equipment may affect setting times. The plaster must be added to clean cold tap water and mixed to an even consistency. Over-mixing with a mechanical mixer may affect the setting time.

7.7 Level of finish

Confirm Compliance: Ensure that the installation complies with the NZBC requirements and that all components used are approved for fire-rated construction. Document any deviations or corrections made during installation

Level 3 shall be used in areas that do not require decoration (for example, above ceiling level or inside service shafts and the like).

All joints and interior angles shall have tape embedded in jointing cement/jointing compound and one separate coat of jointing cement/jointing compound applied over all joints and fastener heads. All jointing cement/jointing compound shall be finished smooth.

Level 4 shall be the default level for gypsum lining. Flat, matt or low sheen paints shall be used for this Level 4.

All joints and interior angles shall have tape embedded in jointing cement/jointing compound and a minimum of two separate coats of jointing cement/jointing compound applied over all joints, angles, fastener heads and accessories. All jointing cement/jointing compound shall be finished evenly and be free of tool marks and ridges in preparation for decoration.

Level 5 shall be used where gloss or semi-gloss paints are to be used or where critical lighting conditions occur on flat, matt or low sheen paints. A Level 5 finish is characterized by a parity of texture and porosity. The surface texture shall be random in fashion and monolithic, concealing joints and fixing points.

All joints and interior angles shall have tape embedded into jointing cement/jointing compound and a minimum of two separate coats of jointing cement/jointing compound applied over all joints, angles, fastener heads and accessories. All jointing cements/jointing compounds shall be finished free of tool marks and ridges.

A paint or plaster material shall then be sprayed, rolled or trowelled over the defined area.

For future information of levels of finishes, refer to AS/NZS 2589.2017

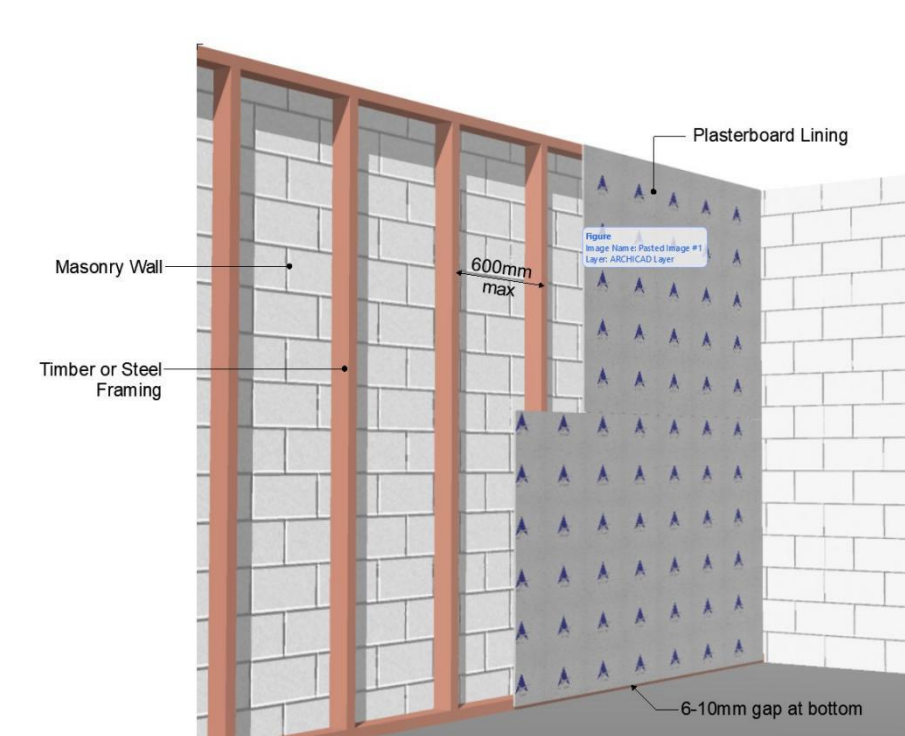
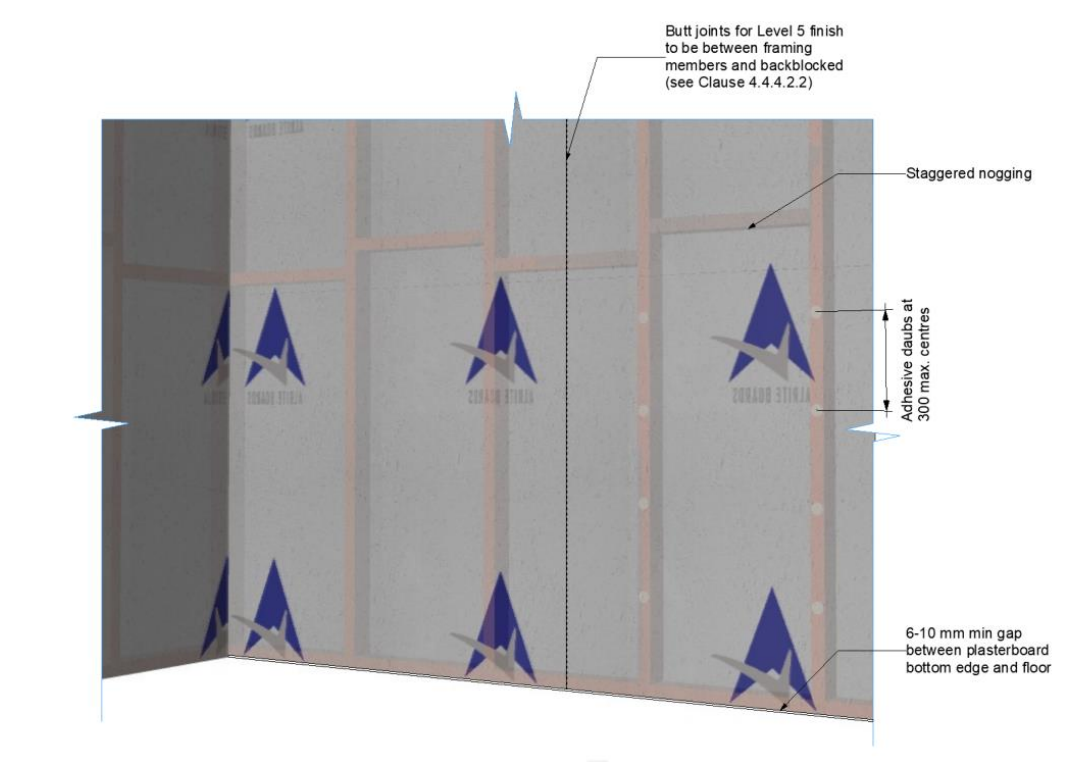

WHAT IS THE FINAL DECORATION?

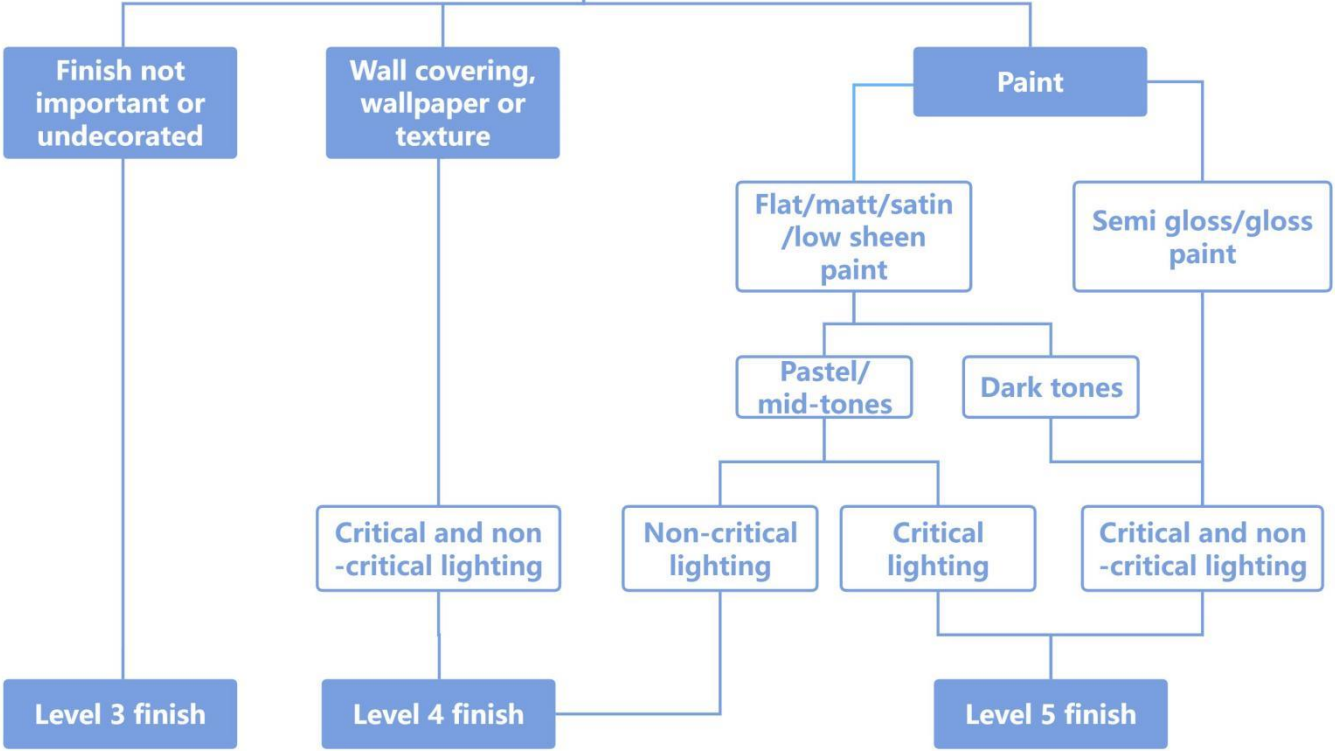

8. Maintenance

8.1 General Maintenance

Maintaining the Alrite Fireshield Fire Rated System is essential to ensure that it continues to provide effective fire resistance throughout the life of the building. Regular inspections and timely repairs are critical components of this maintenance.

8.1 Routine Inspections

Regular inspections should be conducted at least once a year to identify any potential issues that could compromise the fire resistance of the system:

Visual Inspection:

Check for visible signs of damage, such as cracks, gaps, or holes in the Fireshield boards. Inspect the joints and seams for signs of wear or separation.

Check for Moisture:

Inspect the system for any signs of moisture intrusion, which could weaken the plasterboard and reduce fire resistance. Pay particular attention to areas near plumbing, windows, and exterior walls.

Review Sealants and Joint Compounds:

Examine all sealants and joint compounds for signs of degradation, cracking, or separation. Replace any compromised materials immediately.

8.2 Damage Repair

If any damage is detected during an inspection, it should be repaired promptly to maintain the fire rating of the system:

Minor Repairs:

Small cracks or holes can be repaired using fire-rated joint compound. Apply the compound over the damaged area, allow it to dry, and sand it

smooth before applying a finishing coat.

Major Repairs:

For larger areas of damage, such as extensive cracking or holes, the affected section of the Fireshield board may need to be replaced. Cut out the damaged section, fit a new piece of Fireshield board, and finish the joints with fire-rated tape and compound.

Re-Sealing Penetrations:

If penetrations have been altered or new ones added, ensure that they are properly sealed with fire-rated sealant or intumescent material. Any changes to the building's services should be assessed for their impact on the fire rating.

8.3 Maintaining Fire Integrity

To ensure the ongoing fire integrity of the system, it is important to:

Monitor Environmental Conditions:

Keep the Fireshield system dry and free from exposure to high humidity or direct moisture. Ensure that any leaks or water damage are repaired immediately.

Control Building Movement:

Monitor the building for signs of movement that could affect the Fireshield system, such as settling or shifting. Install additional control joints if necessary to accommodate movement.

Avoid Overloading:

Ensure that the Fireshield boards are not subjected to excessive loads, such as heavy shelving or fixtures that could compromise their fire resistance. If additional support is required, reinforce the framing accordingly.

8.4 Record Keeping

Maintain detailed records of all inspections, repairs, and maintenance activities:

Inspection Reports:

Document the findings of each inspection, noting any issues identified and the actions taken to address them.

Repair Logs:

Keep a log of all repairs made to the Fireshield system, including the materials used and the date of the repair.

Compliance Documentation:

Ensure that all repairs and modifications comply with the NZBC and are carried out by qualified professionals. Retain copies of compliance certificates and warranties for reference.

8.5 Seeking Further Guidance

8.5.1 Access to Information: For comprehensive maintenance instructions following damage to Alrite Boards plasterboard linings or for advice on conducting appropriate remediation work, reference to the published Alrite Boards technical literature is advised. This literature contains detailed guidance on maintaining and repairing Alrite Boards plasterboard to uphold its quality and compliance.

8.5.2 Professional Support: For further assistance or clarification on maintenance and remediation processes, the Alrite Boards Helpline is available to provide expert advice and support. Our dedicated team is committed to assisting with queries and ensuring that your Alrite Boards plasterboard installations continue to meet and exceed industry standards.

Email Support: info@alriteboards.com

9. Warranty

The Alrite Fireshield Systems, including the plasterboard linings and their associated fixings, are designed to have a serviceable life of at least 50 years. The durability and long-term performance of these systems are highly dependent on proper installation and ongoing maintenance. To ensure the systems remain effective over their lifespan, it is crucial that they are kept dry during service and maintained in accordance with the guidelines and recommendations provided in this manual. Regular inspections and prompt repairs of any damage or wear are necessary to preserve the integrity and functionality of the Fireshield Systems.

9.1 Alrite Boards's Quality Guarantee

9.1.1 Alrite Boards is committed to excellence, offering high-quality plasterboard products and systems designed to meet the rigorous standards of the construction industry and ensuring customer satisfaction. Our Fireshield products come with a warranty for a 15 years from the date of purchase, underscoring our confidence in their quality and durability.

9.1.2 Warranty Coverage

Scope of Coverage: The warranty covers:

- Defects in the Fireshield plasterboard, including issues related to fire resistance, structural integrity, and durability.
- Failure of the system components, such as jointing tapes, compounds, sealants, and fasteners, that are specifically recommended and used in conjunction with the Fireshield system.
- Performance issues directly resulting from the manufacturing process or material defects.

Duration: Alrite Fireshield products are covered by this warranty for 15 years from the purchase date.

Defect-Free Guarantee: Alrite Boards warrant that Alrite Fireshield products will be free from defects in workmanship or materials, in line with specifications outlined in our technical documentation.

Remedy for Defective Products: Should any Alrite Plasterboard product be found defective, Alrite Boards will, at its discretion, replace or repair the product, assuming the product's installation followed our guidelines.

9.2 Conditions of the Warranty

Consumer Protections: This warranty respects all rights under the Consumer Guarantees Act, not restricting or altering any legal protections.

9.2.1 Claim Submission: Claims regarding product defects must be submitted in writing within 30 days of recognizing the defect, or prior to installation if the defect was apparent beforehand. Proof of purchase is required.

9.2.2 Compliance with Building Standards: The application of Alrite Boards products must adhere strictly to the New Zealand Building Code and other relevant standards and regulations.

9.2.3 Initial Application: This warranty is valid only for the product's initial application, provided the product was used and maintained as per Alrite Boards' instructions. It does not cover the reuse of any product.

9.2.4 Resolution Process: Alrite Boards will work with the customer to resolve valid claims, which may include product replacement or repair. The company's liability is specifically defined within this warranty scope.

9.2.5 Exclusions: This warranty does not cover issues arising from external factors beyond Alrite Boards' control, including but not limited to poor workmanship, environmental conditions, and the

use of incompatible materials.

9.2.6 System Integration: While Alrite Boards provides guidance and assistance, it is the responsibility of the project's stakeholders to ensure that the application is suitable for their specific needs.

9.2.7 Misuse and Abuse: This warranty does not cover damages or defects resulting from misuse, abuse, improper storage or handling, installation not in accordance with Alrite Fireshield's technical literature, or modifications made to the product after leaving the factory.

9.2.8 Normal Wear and Tear: The warranty does not cover normal wear and tear or cosmetic issues that do not affect the structural integrity or performance of the plasterboard products

9.2.9 Exclusion of Additional Warranties: Other than what is explicitly mentioned in this warranty, Alrite Boards excludes additional warranties to the extent permitted by law.

9.3 Claiming Under the Warranty

To claim under this warranty, the product owner must notify Alrite Boards, providing a detailed description of the issue and proof of purchase. Alrite Boards is committed to addressing and resolving valid claims in a manner that reflects our high standards of customer service and support.

Alrite Fireshield

Alrite Plasterboard is manufactured by Knauf. Construction projects are multifaceted, influenced by a myriad of factors that determine the suitability of specific construction techniques and products. To navigate these complexities effectively, Alrite Board underscores the importance of professional consultation, the necessity of accessing and utilizing the latest technical information, and the advantages of relying on products with CodeMark certification.

Seeking Professional Advice and Qualified Installation

Before initiating any construction project with Alrite Board Fireshield, it's crucial to seek expert advice. This ensures that the construction techniques employed are optimally suited to the unique circumstances of your project. Alrite Boards strongly advises the use of qualified tradespersons for the system's installation, ensuring adherence to the highest standards of quality and regulatory compliance.

Ensuring Access to Current Technical Information

The technical data contained within this manual was accurate as of the time of publication. However, the dynamic nature of the construction industry means that building systems, installation details, and product availability are subject to change. Alrite Boards advocates for regularly consulting the most current building information on our website. This commitment to staying informed ensures that your project decisions are based on the latest, most

relevant data, aligning with industry advancements and regulatory updates.

CodeMark stands as a voluntary product certification scheme in Aotearoa New Zealand, signifying that a building product or method meets the New Zealand Building Code requirements. The presence of a CodeMark certificate mandates Building Consent Authorities to accept the certified product or method as complying with the Building Code, assuming the certificate is up-to-date and the product is applied according to its specifications. As the only certification scheme deemed to comply, CodeMark certification is invaluable for ensuring and demonstrating Building Code compliance, providing peace of mind and streamlined approval processes.

Further Information and Support

Alrite Boards is dedicated to offering comprehensive support throughout your project. For additional information, clarification on installation practices, or inquiries about CodeMark certification, please do not hesitate to contact our support team. We are here to assist you with expert advice and support, ensuring your construction project with Alrite Fireshield meets your expectations for quality, safety, and compliance.

Please verify the currency of this publication before proceeding to ensure reliance on the most up-to-date information. Alrite Board does not assume liability for the application of superseded information. For the latest edition of this manual and further support:

Website: www.alriteboards.com



ALRITE PLASTERBOARD

